

IRG4PF50WD

INSULATED GATE BIPOLAR TRANSISTOR WITH ULTRAFAST SOFT RECOVERY DIODE

Features

- Optimized for use in Welding and Switch-Mode Power Supply applications
- Industry benchmark switching losses improve efficiency of all power supply topologies
- 50% reduction of Eoff parameter
- Low IGBT conduction losses
- Latest technology IGBT design offers tighter parameter distribution coupled with exceptional reliability
- IGBT co-packaged with HEXFRED™ ultrafast, ultra-soft-recovery anti-parallel diodes for use in bridge configurations
- Industry standard TO-247AC package

Benefits

- Lower switching losses allow more cost-effective operation and hence efficient replacement of larger-die MOSFETs up to 100kHz
- HEXFRED™ diodes optimized for performance with IGBTs. Minimized recovery characteristics reduce noise, EMI and switching losses

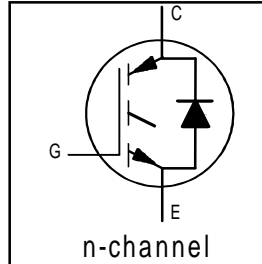

$V_{CES} = 900V$
 $V_{CE(on) typ.} = 2.25V$
 @ $V_{GE} = 15V, I_C = 28A$

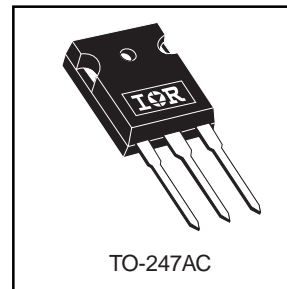

Absolute Maximum Ratings

	Parameter	Max.	Units
V_{CES}	Collector-to-Emitter Breakdown Voltage	900	V
$I_C @ T_C = 25^\circ C$	Continuous Collector Current	51	A
$I_C @ T_C = 100^\circ C$	Continuous Collector Current	28	
I_{CM}	Pulsed Collector Current ①	204	
I_{LM}	Clamped Inductive Load Current ②	204	
$I_F @ T_C = 100^\circ C$	Diode Continuous Forward Current	16	
I_{FM}	Diode Maximum Forward Current	204	
V_{GE}	Gate-to-Emitter Voltage	± 20	V
$P_D @ T_C = 25^\circ C$	Maximum Power Dissipation	200	W
$P_D @ T_C = 100^\circ C$	Maximum Power Dissipation	78	
T_J T_{STG}	Operating Junction and Storage Temperature Range	-55 to + 150	°C
	Soldering Temperature, for 10 seconds	300 (0.063 in. (1.6mm) from case)	
	Mounting torque, 6-32 or M3 screw.	10 lbf•in (1.1N•m)	

Thermal Resistance

	Parameter	Min.	Typ.	Max.	Units
$R_{\theta JC}$	Junction-to-Case - IGBT	—	—	0.64	°C/W
$R_{\theta JC}$	Junction-to-Case - Diode	—	—	0.83	
$R_{\theta CS}$	Case-to-Sink, flat, greased surface	—	0.24	—	
$R_{\theta JA}$	Junction-to-Ambient, typical socket mount	—	—	40	
W_t	Weight	—	6 (0.21)	—	g (oz)

Electrical Characteristics @ T_J = 25°C (unless otherwise specified)

	Parameter	Min.	Typ.	Max.	Units	Conditions
V _{(BR)CES}	Collector-to-Emitter Breakdown Voltage ^③	900	—	—	V	V _{GE} = 0V, I _C = 250μA
ΔV _{(BR)CES/ΔT_J}	Temperature Coeff. of Breakdown Voltage	—	0.295	—	V/°C	V _{GE} = 0V, I _C = 3.5mA
V _{CE(on)}	Collector-to-Emitter Saturation Voltage	—	2.25	2.7	V	I _C = 28A V _{GE} = 15V
		—	2.74	—		I _C = 60A See Fig. 2, 5
		—	2.12	—		I _C = 28A, T _J = 150°C
V _{GE(th)}	Gate Threshold Voltage	3.0	—	6.0		V _{CE} = V _{GE} , I _C = 250μA
ΔV _{GE(th)/ΔT_J}	Temperature Coeff. of Threshold Voltage	—	-13	—	mV/°C	V _{CE} = V _{GE} , I _C = 250μA
g _{fe}	Forward Transconductance ^④	26	39	—	S	V _{CE} = 50V, I _C = 28A
I _{CES}	Zero Gate Voltage Collector Current	—	—	500	μA	V _{GE} = 0V, V _{CE} = 900V
		—	—	2.0		V _{GE} = 0V, V _{CE} = 10V, T _J = 25°C
		—	—	6.5	mA	V _{GE} = 0V, V _{CE} = 900V, T _J = 150°C
V _{FM}	Diode Forward Voltage Drop	—	2.5	3.5	V	I _C = 16A See Fig. 13
		—	2.1	3.0		I _C = 16A, T _J = 150°C
I _{GES}	Gate-to-Emitter Leakage Current	—	—	±100	nA	V _{GE} = ±20V

Switching Characteristics @ T_J = 25°C (unless otherwise specified)

	Parameter	Min.	Typ.	Max.	Units	Conditions
Q _g	Total Gate Charge (turn-on)	—	160	240	nC	I _C = 28A V _{CC} = 400V See Fig. 8 V _{GE} = 15V
Q _{ge}	Gate - Emitter Charge (turn-on)	—	19	29		
Q _{gc}	Gate - Collector Charge (turn-on)	—	53	80		
t _{d(on)}	Turn-On Delay Time	—	71	—	ns	T _J = 25°C I _C = 28A, V _{CC} = 720V V _{GE} = 15V, R _G = 5.0Ω Energy losses include "tail" and diode reverse recovery. See Fig. 9, 10, 18
t _r	Rise Time	—	50	—		
t _{d(off)}	Turn-Off Delay Time	—	150	220		
t _f	Fall Time	—	110	170	mJ	T _J = 150°C, See Fig. 11, 18 I _C = 28A, V _{CC} = 720V V _{GE} = 15V, R _G = 5.0Ω Energy losses include "tail" and diode reverse recovery.
E _{on}	Turn-On Switching Loss	—	2.63	—		
E _{off}	Turn-Off Switching Loss	—	1.34	—		
E _{ts}	Total Switching Loss	—	3.97	5.3	mJ	Measured 5mm from package
t _{d(on)}	Turn-On Delay Time	—	69	—		
t _r	Rise Time	—	52	—		
t _{d(off)}	Turn-Off Delay Time	—	270	—	ns	T _J = 150°C, See Fig. 11, 18 I _C = 28A, V _{CC} = 720V V _{GE} = 15V, R _G = 5.0Ω Energy losses include "tail" and diode reverse recovery.
t _f	Fall Time	—	190	—		
E _{ts}	Total Switching Loss	—	6.0	—		
L _E	Internal Emitter Inductance	—	13	—	nH	Measured 5mm from package
C _{ies}	Input Capacitance	—	3300	—	pF	V _{GE} = 0V V _{CC} = 30V See Fig. 7 f = 1.0MHz
C _{oes}	Output Capacitance	—	200	—		
C _{res}	Reverse Transfer Capacitance	—	45	—		
t _{rr}	Diode Reverse Recovery Time	—	90	135	ns	T _J = 25°C See Fig. 14
		—	164	245		T _J = 125°C
I _{rr}	Diode Peak Reverse Recovery Current	—	5.8	10	A	T _J = 25°C See Fig. 15
		—	8.3	15		T _J = 125°C
		—	—	—		T _J = 150°C
Q _{rr}	Diode Reverse Recovery Charge	—	260	675	nC	T _J = 25°C See Fig. 16
		—	680	1838		T _J = 125°C
di _(rec) M/dt	Diode Peak Rate of Fall of Recovery During t _b	—	120	—	A/μs	T _J = 25°C See Fig. 17
		—	76	—		T _J = 125°C

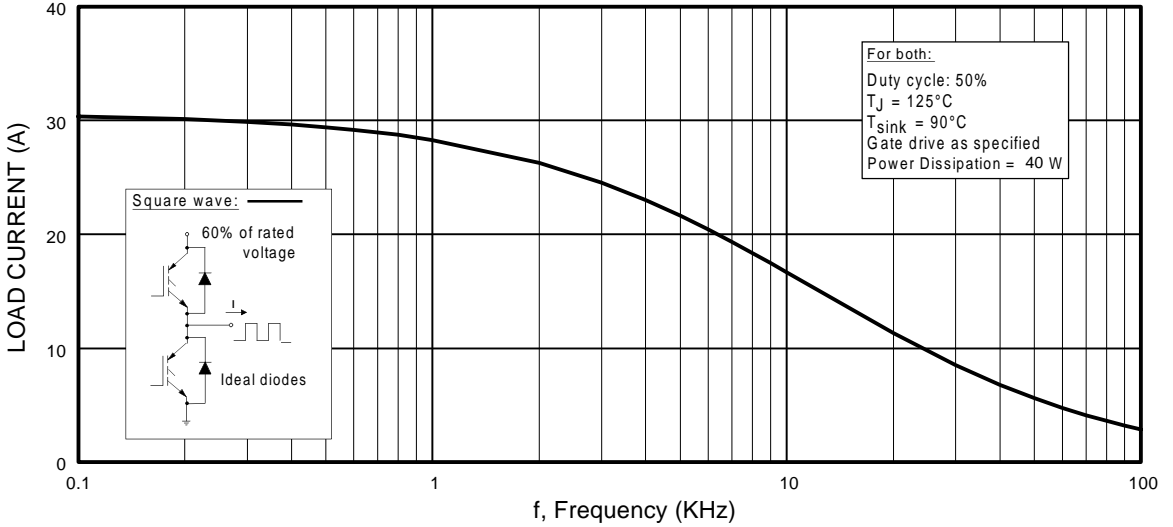

Fig. 1 - Typical Load Current vs. Frequency
 (Load Current = I_{RMS} of fundamental)

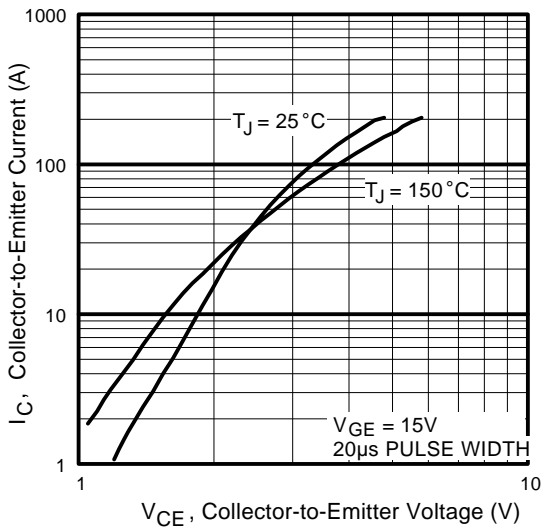

Fig. 2 - Typical Output Characteristics

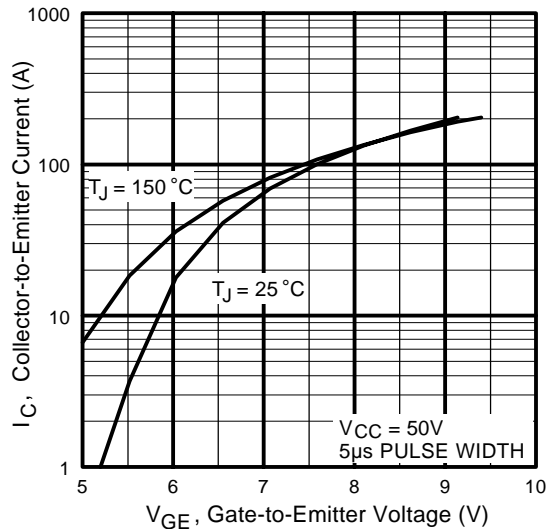

Fig. 3 - Typical Transfer Characteristics

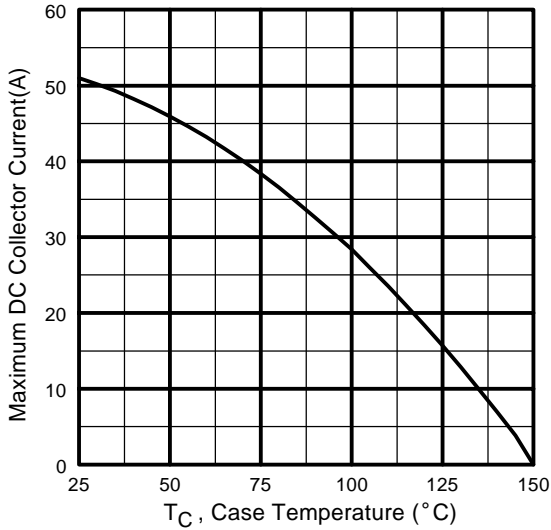

Fig. 4 - Maximum Collector Current vs. Case Temperature

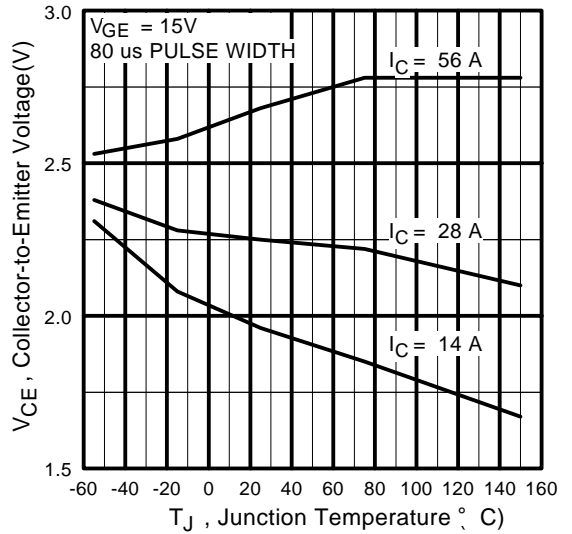

Fig. 5 - Collector-to-Emitter Voltage vs. Junction Temperature

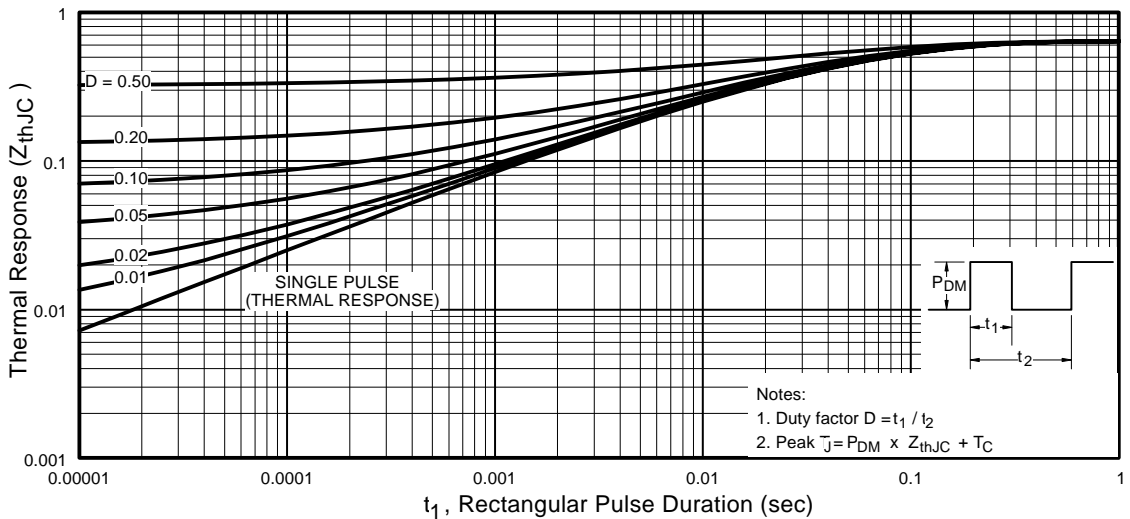

Fig. 6 - Maximum Effective Transient Thermal Impedance, Junction-to-Case

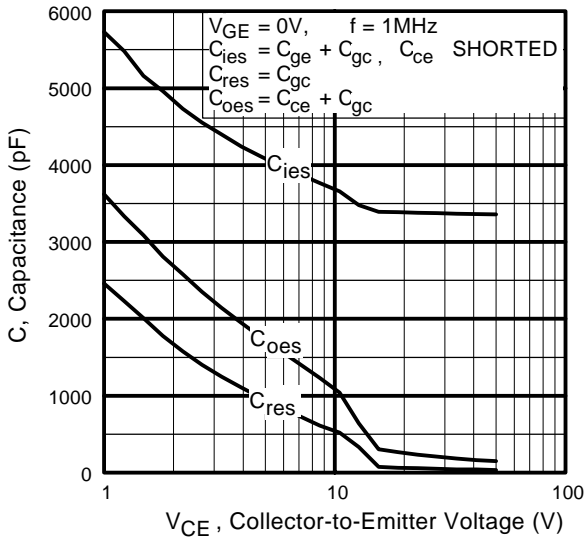

Fig. 7 - Typical Capacitance vs. Collector-to-Emitter Voltage

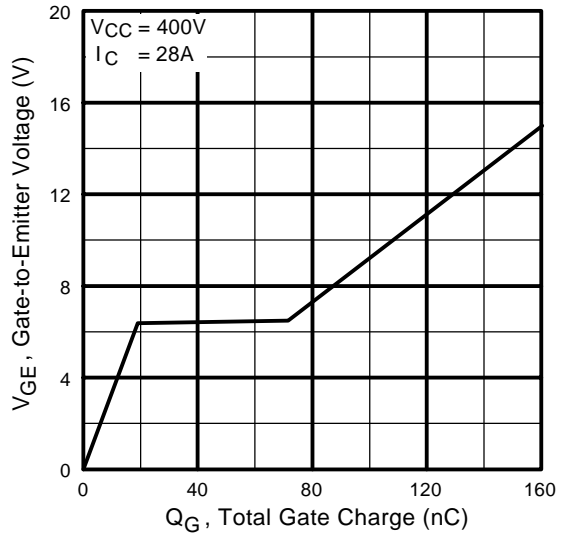

Fig. 8 - Typical Gate Charge vs. Gate-to-Emitter Voltage

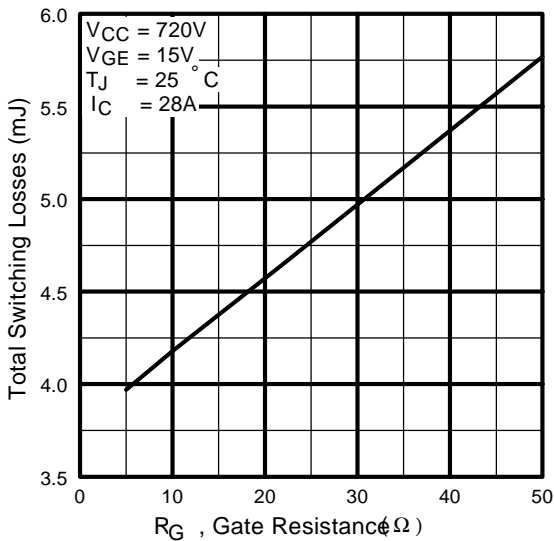

Fig. 9 - Typical Switching Losses vs. Gate Resistance

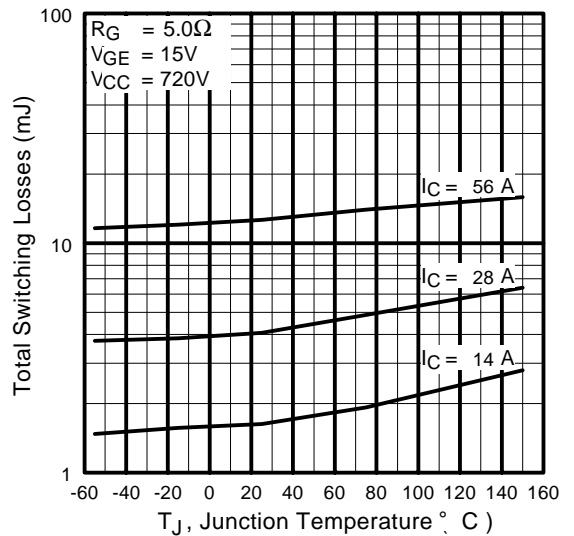

Fig. 10 - Typical Switching Losses vs. Junction Temperature

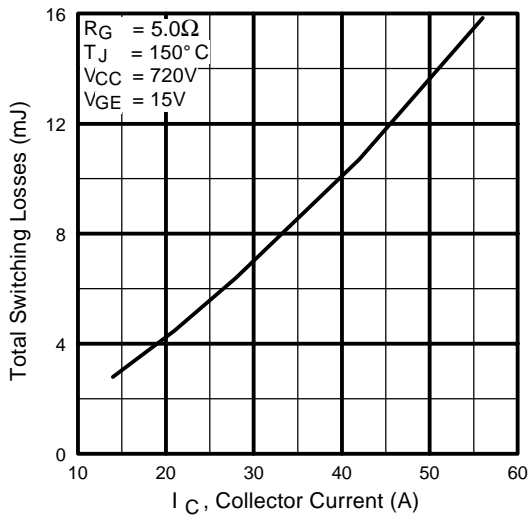

Fig. 11 - Typical Switching Losses vs. Collector-to-Emitter Current

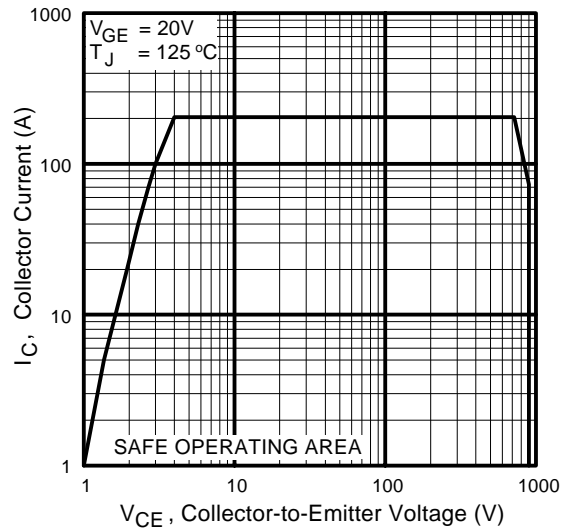

Fig. 12 - Turn-Off SOA

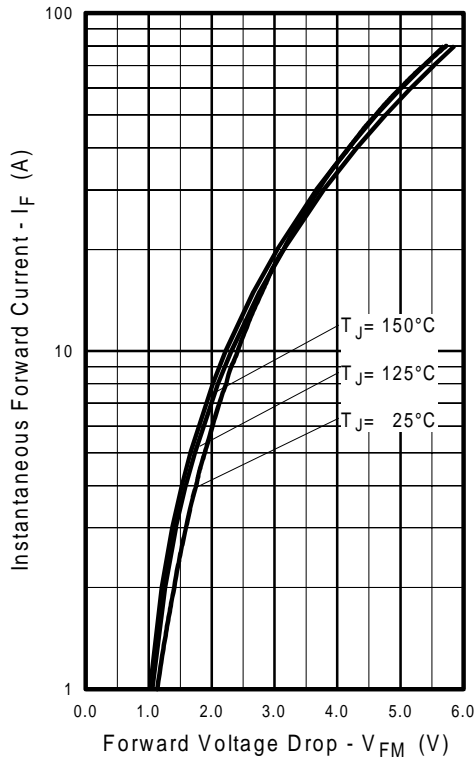

Fig. 13 - Typical Forward Voltage Drop vs. Instantaneous Forward Current

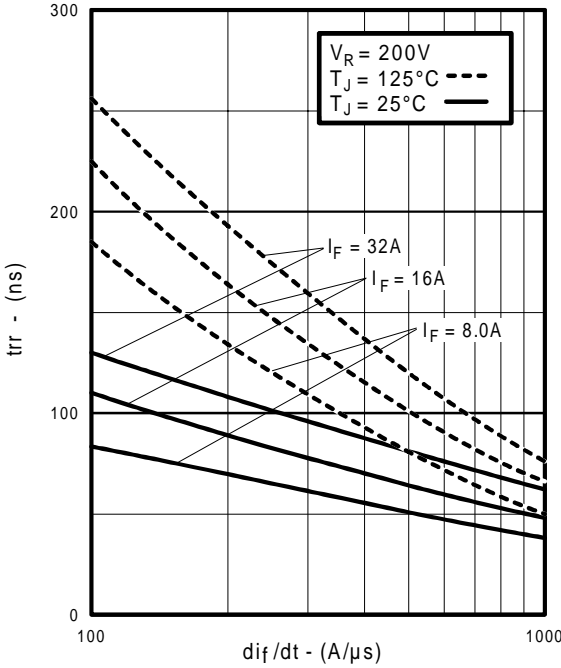

Fig. 14 - Typical Reverse Recovery vs. di_f/dt

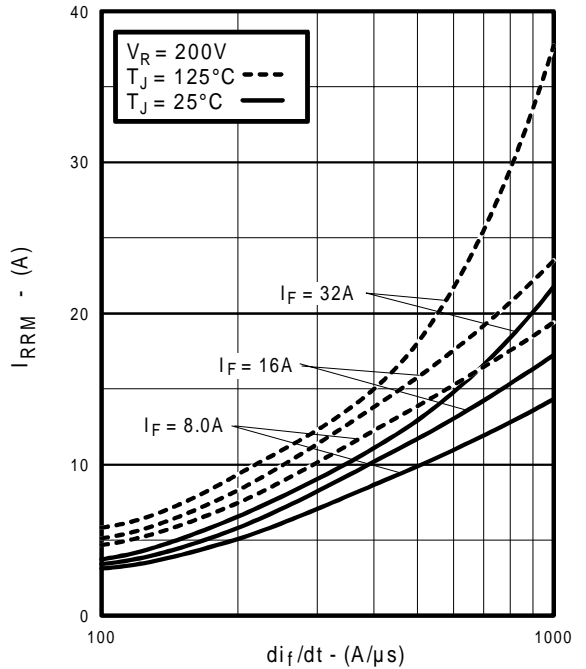

Fig. 15 - Typical Recovery Current vs. di_f/dt

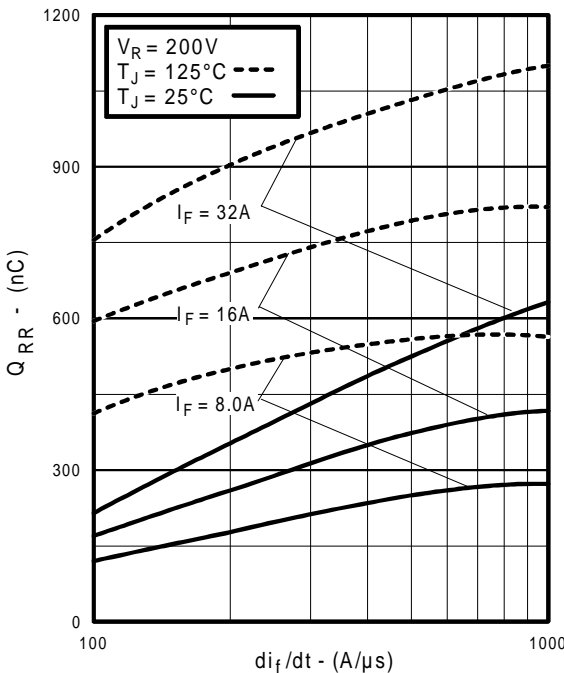

Fig. 16 - Typical Stored Charge vs. di_f/dt

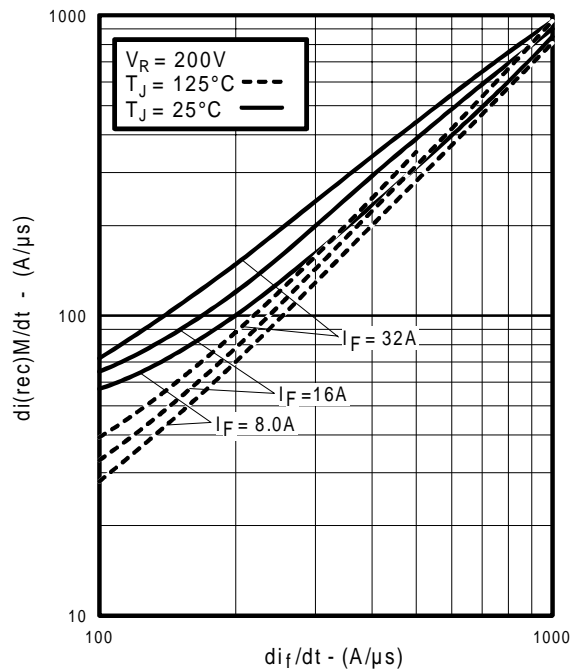

Fig. 17 - Typical $di_{(rec)M}/dt$ vs. di_f/dt

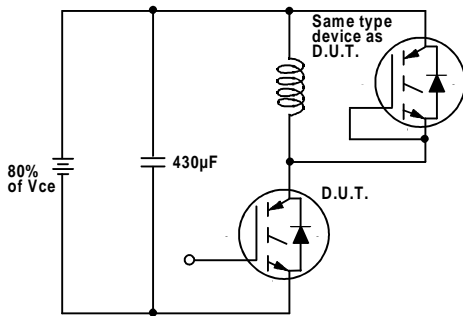

Fig. 18a - Test Circuit for Measurement of I_{LM} , E_{on} , $E_{off}(\text{diode})$, t_{rr} , Q_{rr} , I_{rr} , $t_{d(on)}$, t_r , $t_{d(off)}$, t_f

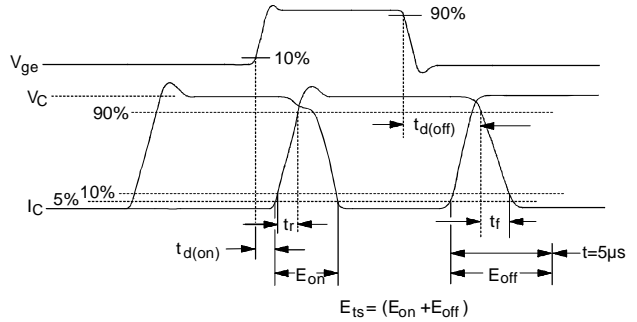

Fig. 18b - Test Waveforms for Circuit of Fig. 18a, Defining E_{off} , $t_{d(off)}$, t_f

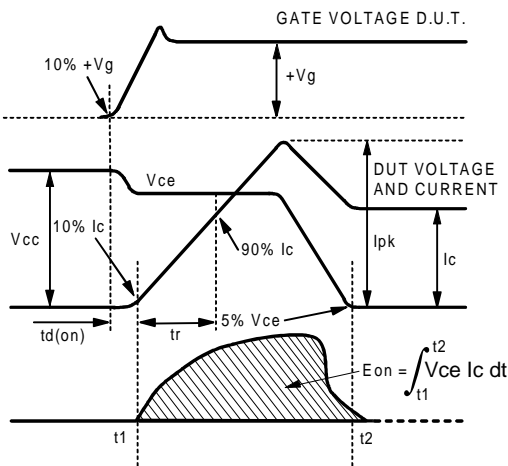

Fig. 18c - Test Waveforms for Circuit of Fig. 18a, Defining E_{on} , $t_{d(on)}$, t_r

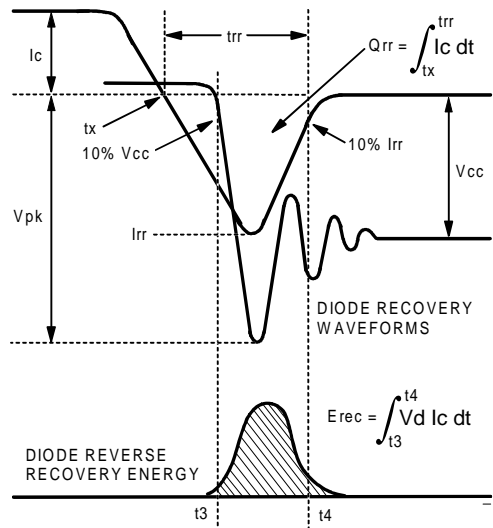

Fig. 18d - Test Waveforms for Circuit of Fig. 18a, Defining E_{rec} , t_{rr} , Q_{rr} , I_{rr}

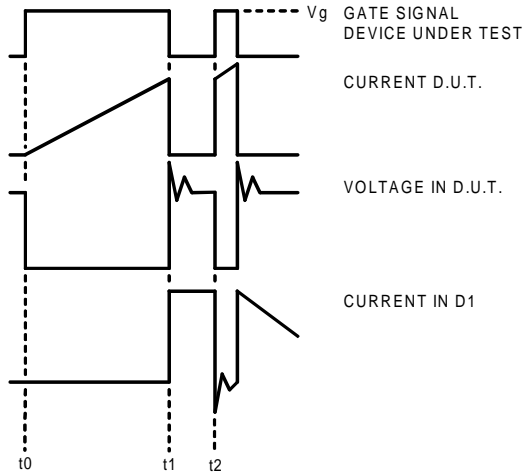

Figure 18e. Macro Waveforms for Figure 18a's Test Circuit

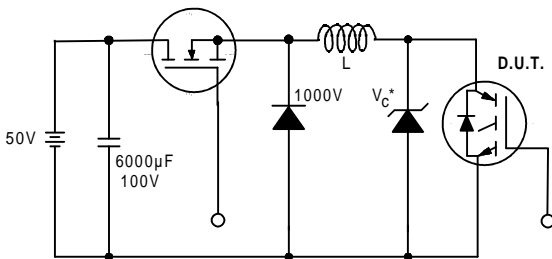

Figure 19. Clamped Inductive Load Test Circuit

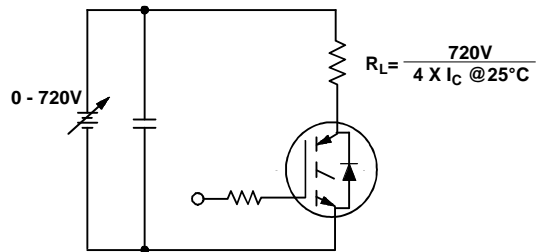
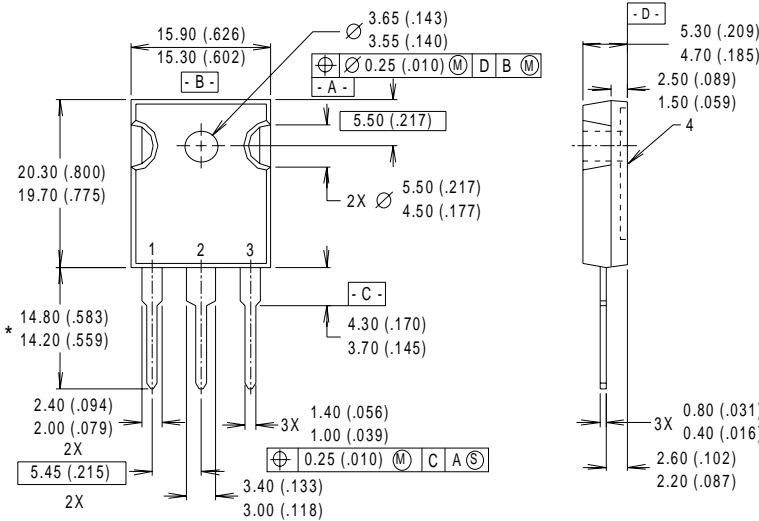

Figure 20. Pulsed Collector Current Test Circuit

Notes:

- ① Repetitive rating: $V_{GE}=20V$; pulse width limited by maximum junction temperature (figure 20)
- ② $V_{CC}=80\%(V_{CES})$, $V_{GE}=20V$, $L=10\mu H$, $R_G=5.0\Omega$ (figure 19)
- ③ Pulse width $\leq 80\mu s$; duty factor $\leq 0.1\%$.
- ④ Pulse width $5.0\mu s$, single shot.

Case Outline and Dimensions — TO-247AC



NOTES:

- 1 DIMENSIONS & TOLERANCING PER ANSI Y14.5M, 1982.
- 2 CONTROLLING DIMENSION : INCH.
- 3 DIMENSIONS ARE SHOWN MILLIMETERS (INCHES).
- 4 CONFORMS TO JEDEC OUTLINE TO-247AC.

LEAD ASSIGNMENTS

- 1 - GATE
- 2 - COLLECTOR
- 3 - EMITTER
- 4 - COLLECTOR

* LONGER LEADED (20mm) VERSION AVAILABLE (TO-247AD) TO ORDER ADD "E" SUFFIX TO PART NUMBER

CONFORMS TO JEDEC OUTLINE TO-247AC (TO-3P)

Dimensions in Millimeters and (Inches)

WORLD HEADQUARTERS: 233 Kansas St., El Segundo, California 90245, Tel: (310) 322 3331

IR GREAT BRITAIN: Hurst Green, Oxted, Surrey RH8 9BB, UK Tel: ++ 44 1883 732020

IR CANADA: 15 Lincoln Court, Brampton, Ontario L6T3Z2, Tel: (905) 453 2200

IR GERMANY: Saalburgstrasse 157, 61350 Bad Homburg Tel: ++ 49 6172 96590

IR ITALY: Via Liguria 49, 10071 Borgaro, Torino Tel: ++ 39 11 451 0111

IR FAR EAST: K&H Bldg., 2F, 30-4 Nishi-Ikebukuro 3-Chome, Toshima-Ku, Tokyo Japan 171 Tel: 81 3 3983 0086

IR SOUTHEAST ASIA: 315 Outram Road, #10-02 Tan Boon Liat Building, Singapore 0316 Tel: 65 221 8371

IR TAIWAN: 16 Fl. Suite D. 207, Sec. 2, Tun Haw South Road, Taipei, 10673, Taiwan Tel: 886-2-2377-9936

<http://www.irf.com/> Data and specifications subject to change without notice. 7/98

Note: For the most current drawings please refer to the IR website at:
<http://www.irf.com/package/>