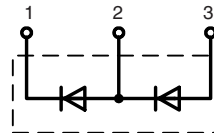
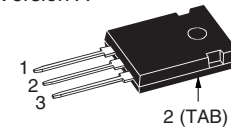
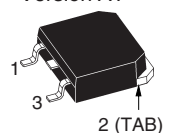
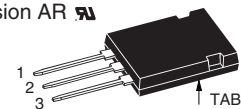

Phase-leg Rectifier Diode

$V_{RRM} = 1200/1600 \text{ V}$
 $I_{F(RMS)} = 2 \times 70 \text{ A}$
 $I_{F(AV)M} = 2 \times 45 \text{ A}$

V_{RSM}	V_{RRM}	TO-247 AD	TO-268 AA	ISOPLUS247™
V	V	Type		
1300	1200	DSP 45-12A	DSP 45-12AT	
1700	1600	DSP 45-16A	DSP 45-16AT	DSP 45-16AR

TO-247 AD
Version A

TO-268 AA
Version AT

ISOPLUS 247™
Version AR

1 = Cathode, 2 = Anode/Cathode, 3 = Anode

Symbol	Conditions	Maximum Ratings	
$I_{F(RMS)}$	$T_{VJ} = T_{VJM}$	70	A
$I_{F(AV)M}$	$T_C = 130^\circ\text{C}; 180^\circ \text{ sine}$	45	A
$I_{F(AV)M}^{(2)}$	$T_C = 100^\circ\text{C}; 180^\circ \text{ sine}$	43	A
I_{FSM}	$T_{VJ} = 45^\circ\text{C};$ $t = 10 \text{ ms}$ (50 Hz), sine $t = 8.3 \text{ ms}$ (60 Hz), sine	480	A
		510	A
	$T_{VJ} = 150^\circ\text{C};$ $t = 10 \text{ ms}$ (50 Hz), sine $t = 8.3 \text{ ms}$ (60 Hz), sine	420	A
		450	A
I^2t	$T_{VJ} = 45^\circ\text{C}$ $t = 10 \text{ ms}$ (50 Hz), sine $t = 8.3 \text{ ms}$ (60 Hz), sine	1150	A ² s
		1090	A ² s
	$T_{VJ} = 150^\circ\text{C};$ $t = 10 \text{ ms}$ (50 Hz), sine $t = 8.3 \text{ ms}$ (60 Hz), sine	880	A ² s
		855	A ² s
T_{VJ}		-40...+180	°C
T_{VJM}		+180	°C
$T_{VJ}^{(2)}$		-40...+150	°C
$T_{VJM}^{(2)}$		+150	°C
T_{stg}		-40...+150	°C
$M_d^{(1)}$	Mounting torque	1.13/10	Nm/lb.in.
$F_C^{(2+3)}$	Clip mounting force	1.13/10	Nm/lb.in.
$V_{ISOL}^{(2)}$	50/60 Hz, RMS, $t = 1 \text{ minute}$, leads-to-tab	2500	V~
Weight	TO-268 / TO-247	4 / 6	g

¹⁾ Version A; ²⁾ Version AR; ³⁾ Version AT

Features

- International standard packages JEDEC TO-247 AD and TO-268 AA surface mountable
- For single and three phase bridge configuration
- Planar passivated chips
- Epoxy meets UL 94V-0 flammability classification
- Version AR isolated and UL registered E153432

Symbol	Conditions	Characteristic Values	
I_R	$T_{VJ} = 150^\circ\text{C}$ $V_R = V_{RRM}$	≤ 3	mA
V_F	$I_F = 40 \text{ A}; T_{VJ} = 25^\circ\text{C}$	≤ 1.23	V
V_{T0}	For power-loss calculations only	0.8	V
r_T	$T_{VJ} = T_{VJM}$	11	mΩ
R_{thJC}	DC current	0.55	K/W
$R_{thJC}^{(2)}$	DC current	0.7	K/W
R_{thCH}	DC current (with heatsink compound)	0.2	K/W
a	Maximum allowable acceleration	50	m/s ²

Data according to IEC 60747 and refer to a single diode

IXYS reserves the right to change limits, test conditions and dimensions

TO-247 AD

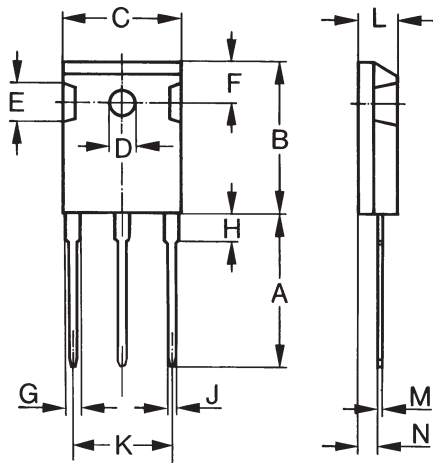

Dim.	Millimeter		Inches	
	Min.	Max.	Min.	Max.
A	19.81	20.32	0.780	0.800
B	20.80	21.46	0.819	0.845
C	15.75	16.26	0.610	0.640
D	3.55	3.65	0.140	0.144
E	4.32	5.49	0.170	0.216
F	5.4	6.2	0.212	0.244
G	1.65	2.13	0.065	0.084
H	-	4.5	-	0.177
J	1.0	1.4	0.040	0.055
K	10.8	11.0	0.426	0.433
L	4.7	5.3	0.185	0.209
M	0.4	0.8	0.016	0.031
N	1.5	2.49	0.087	0.102

ISOPLUS247™

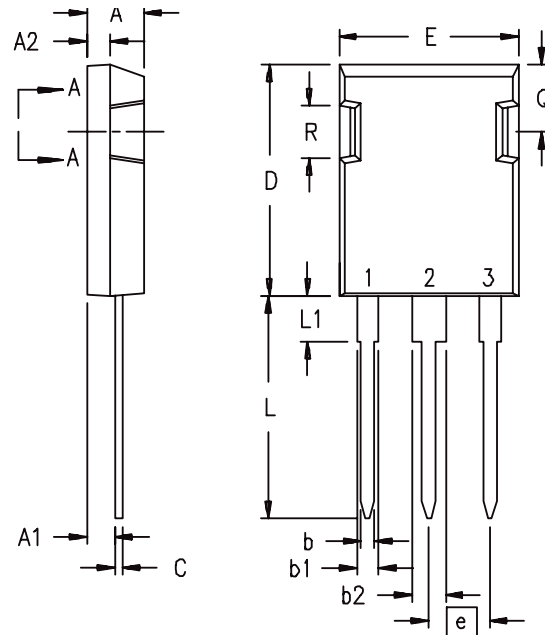

Dim.	Millimeter		Inches	
	Min.	Max.	Min.	Max.
A	4.83	5.21	.190	.205
A ₁	2.29	2.54	.090	.100
A ₂	1.91	2.16	.075	.085
b	1.14	1.40	.045	.055
b ₁	1.91	2.13	.075	.084
b ₂	2.92	3.12	.115	.123
C	0.61	0.80	.024	.031
D	20.80	21.34	.819	.840
E	15.75	16.13	.620	.635
e	5.45 BSC		.215 BSC	
L	19.81	20.32	.780	.800
L ₁	3.81	4.32	.150	.170
Q	5.59	6.20	.220	.244
R	4.32	4.83	.170	.190

Note:
Backside is electr. isolated

TO-268 AA

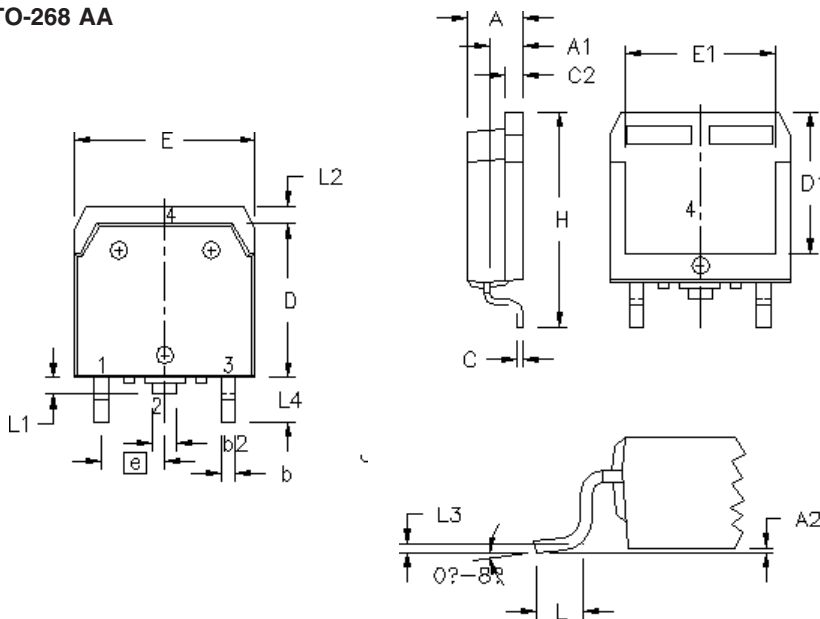

Dim.	Millimeter		Inches	
	Min.	Max.	Min.	Max.
A	4.9	5.1	.193	.201
A ₁	2.7	2.9	.106	.114
A ₂	.02	.25	.001	.010
b	1.15	1.45	.045	.057
b ₂	1.9	2.1	.75	.83
C	.4	.65	.016	.026
D	13.80	14.00	.543	.551
E	15.85	16.05	.624	.632
E ₁	13.3	13.6	.524	.535
e	5.45 BSC		.215 BSC	
H	18.70	19.10	.736	.752
L	2.40	2.70	.094	.106
L ₁	1.20	1.40	.047	.055
L ₂	1.00	1.15	.039	.045
L ₃	0.25 BSC		.010 BSC	
L ₄	3.80	4.10	.150	.161