

DATA SHEET

FUSIBLE CHIP RESISTORS

FR series (Pb Free)

5%

sizes 0603/1206



SCOPE

This specification describes FR0603/1206 fusible chip resistors with lead-free terminations made by thick film process.

ORDERING INFORMATION

Part number is identified by the series, size, tolerance, packing type, temperature coefficient, taping reel and resistance value.

YAGEO ORDERING CODE

CTC CODE

FR XXXX X X X XX XXXX L
 (1) (2) (3) (4) (5) (6) (7)

(1) SIZE

0603/1206

(2) TOLERANCE

J = ±5%

(3) PACKAGING TYPE

R = Paper/PE taping reel

(4) TEMPERATURE COEFFICIENT OF RESISTANCE

- = Base on spec

(5) TAPING REEL

07 = 7 inch dia. Reel

(6) RESISTANCE VALUE

1R, 5R6, 56R, 510R.

(7) RESISTOR TERMINATIONS ^(a)

L = Lead-free terminations (matte tin)

APPLICATIONS

- Power supply in small equipment
- Car telephones
- Portable radio, CD and cassette players

ORDERING EXAMPLE

The ordering code of a FR1206 chip resistor, value 200 Ω with ±5% tolerance, supplied in 7-inch tape reel is: FR1206JR-07200RL.

NOTE

- a. The “L” at the end of the code is only for ordering. On the reel label, the standard CTC or I2NC will be mentioned an additional stamp “LFP”= lead free production.
- b. Products with lead in terminations fulfil the same requirements as mentioned in this datasheet.
- c. Products with lead in terminations will be phased out in the coming months (before July 1st, 2006)

MARKING

FR0603/1206



E-24 series: 3 digits

First two digits for significant figure and 3rd digit for number of zeros

For marking codes, please see EIA-marking code rules in data sheet “Chip resistors marking”.

CONSTRUCTION

The resistors are constructed out of a high-grade ceramic body. Internal metal electrodes are added at each end and connected by a resistive paste. The composition of the paste is adjusted to give the approximate required resistance and laser cutting of this resistive layer that achieves tolerance trims the value. The resistive layer is covered with an overcoat and printed with the resistance value. Finally, the two external terminations (matte tin) are added.

To enable recognition of a fusible device, the resistor should be mounted face up. See fig. 2.

DIMENSIONS

Table I For outlines see fig. 2

TYPE	L (mm)	W (mm)	H (mm)	l ₁ (mm)	l ₂ (mm)
FR0603	1.60 ±0.10	0.80 ±0.10	0.45 ±0.10	0.25 ±0.15	0.25 ±0.15
FR1206	3.10 ±0.10	1.60 ±0.10	0.55 ±0.10	0.45 ±0.20	0.40 ±0.20

OUTLINES

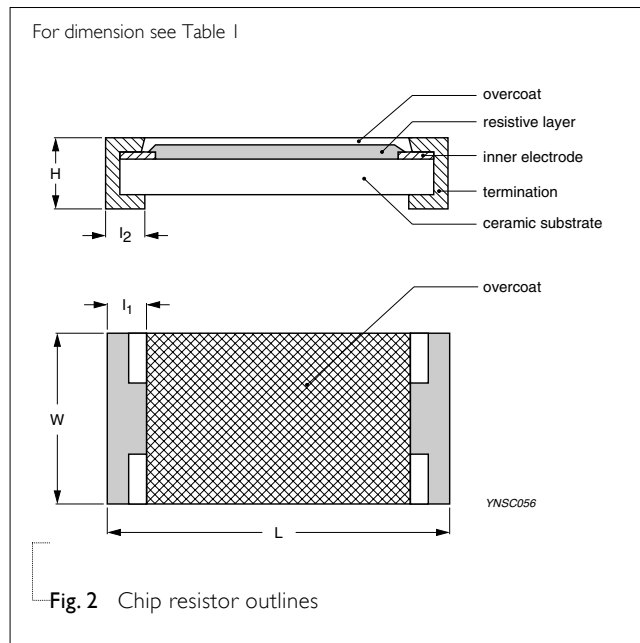

Fig. 2 Chip resistor outlines

ELECTRICAL CHARACTERISTICS

Table 2

TYPE	RESISTANCE RANGE	CHARACTERISTICS				Temperature Coefficient of Resistance
		Operating Temperature Range	Max. Working Voltage	Max. Overload Voltage	Dielectric Withstanding Voltage	
FR0603	±5% (E-24), 1 Ω ≤ R ≤ 240 Ω	-55 °C to +125 °C	50 V	100 V	100 V	1 Ω ≤ R ≤ 10 Ω: 0/+500 ppm/°C 10 Ω < R ≤ 240 Ω: ±200 ppm/°C
FR1206	±5% (E-24), 1 Ω ≤ R ≤ 510 Ω		200 V	500 V	500 V	1 Ω ≤ R < 5 Ω: ±250 ppm/°C 5 Ω ≤ R ≤ 510 Ω: ±200 ppm/°C

FOOTPRINT AND SOLDERING PROFILES

For recommended footprint and soldering profiles, please see the special data sheet “Chip resistors mounting”.

ENVIRONMENTAL DATA

For material declaration information (IMDS-data) of the products, please see the separated info “Environmental data” conformed to EU RoHS.

PACKING STYLE AND PACKAGING QUANTITY

Table 3 Packing style and packaging quantity

PACKING STYLE	REEL DIMENSION	FR0603	FR1206
Paper/PE taping reel (R)	7" (178 mm)	5,000	5,000

NOTE

1. For Paper/PE tape and reel specification/dimensions, please see the special data sheet “Packing” document.

FUNCTIONAL DESCRIPTION

PRODUCT CHARACTERIZATION

Standard values of nominal resistance are taken from the E24 series for resistors with a tolerance of ±5%. The values of the E24 series are in accordance with “IEC publication 60063”.

FUSING CHARACTERISTICS

The resistors will fuse without the risk of fire and within an indicated range of overload. Fusing means that the resistive value of the resistor increases at least 100 times; see Figs 3 and 4.

The fusing characteristic is measured under constant voltage with resistors mounted on a ceramic or glass epoxy (FR4) substrate; see Fig. 5.

This graph is based on measured data, which may deviate according to the application.

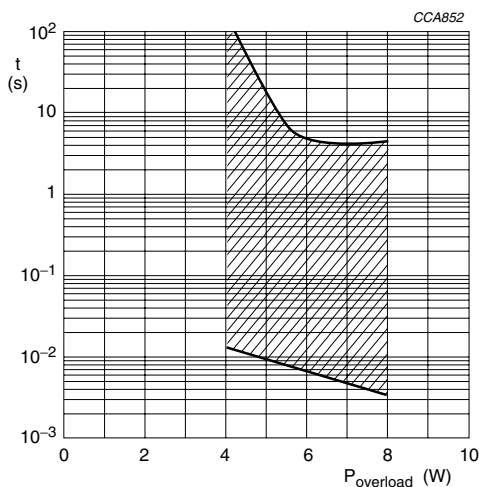

Fig. 3 Fusing characteristic for type FR0603: $1 \Omega \leq R \leq 240 \Omega$ and FR1206: $1 \Omega \leq R \leq 510 \Omega$, measured using ceramic board material.

This graph is based on measured data, which may deviate according to the application.

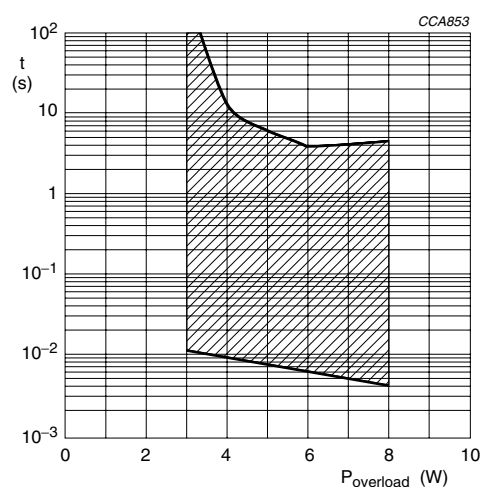
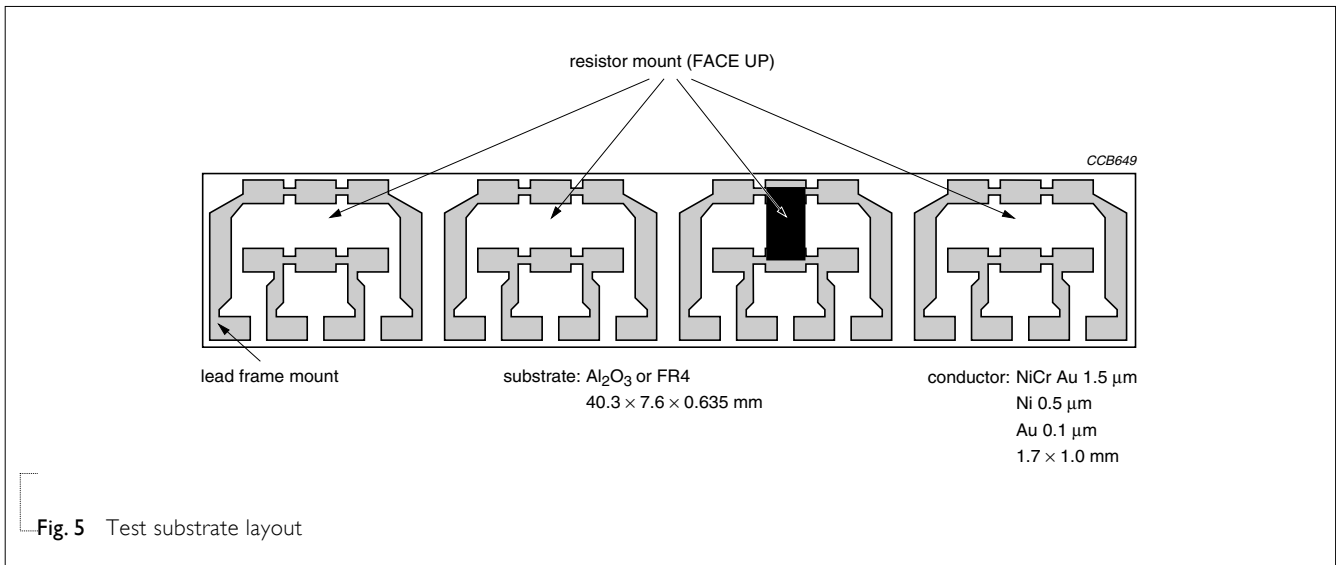

Fig. 4 Fusing characteristic for type FR0603: $1 \Omega \leq R \leq 240 \Omega$ and FR1206: $1 \Omega \leq R \leq 510 \Omega$, measured using glass epoxy (FR4) board material.



OPERATING TEMPERATURE RANGE

Range: -55°C to +125°C

LIMITING VALUES

Table 4

TYPE	LIMITING VOLTAGE ⁽¹⁾ (V)	LIMITING POWER ⁽³⁾ (W)
FR0603	50 ⁽²⁾	1/16
FR1206	200 ⁽²⁾	1/8

NOTES

1. The maximum voltage that may be continuously applied to the resistor element, see "IEC publication 60115-8".
2. The maximum voltage that may be applied after fusing is shown in Fig. 6.
3. Each type rated power at 70°C.

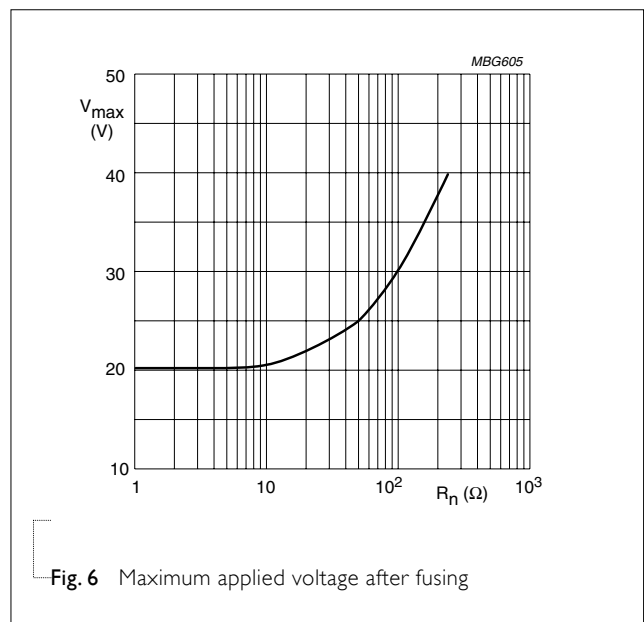

POWER RATING

The power that the resistor can dissipate depends on the operating temperature; see Fig. 7.

RATED VOLTAGE

The DC or AC (rms) continuous working voltage corresponding to the rated power is determined by the following formula:

$$V = \sqrt{P \times R}$$

Where

V = Continuous rated DC or AC (rms) working voltage (V)

P = Rated power (W)

R = Resistance value (Ω)

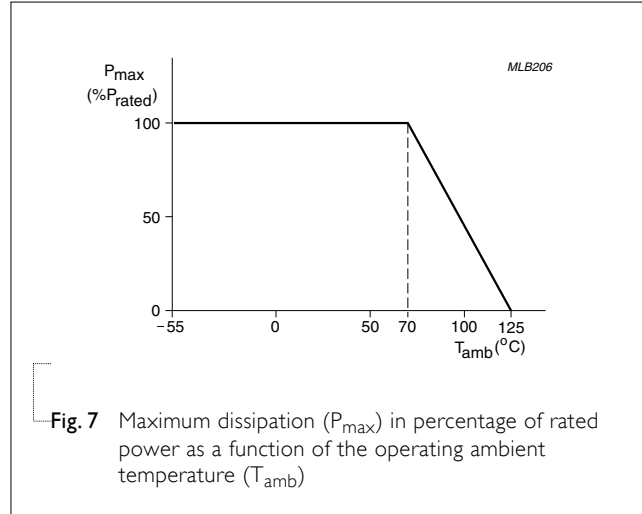

Fig. 7 Maximum dissipation (P_{max}) in percentage of rated power as a function of the operating ambient temperature (T_{amb})

PULSE LOADING CAPABILITIES

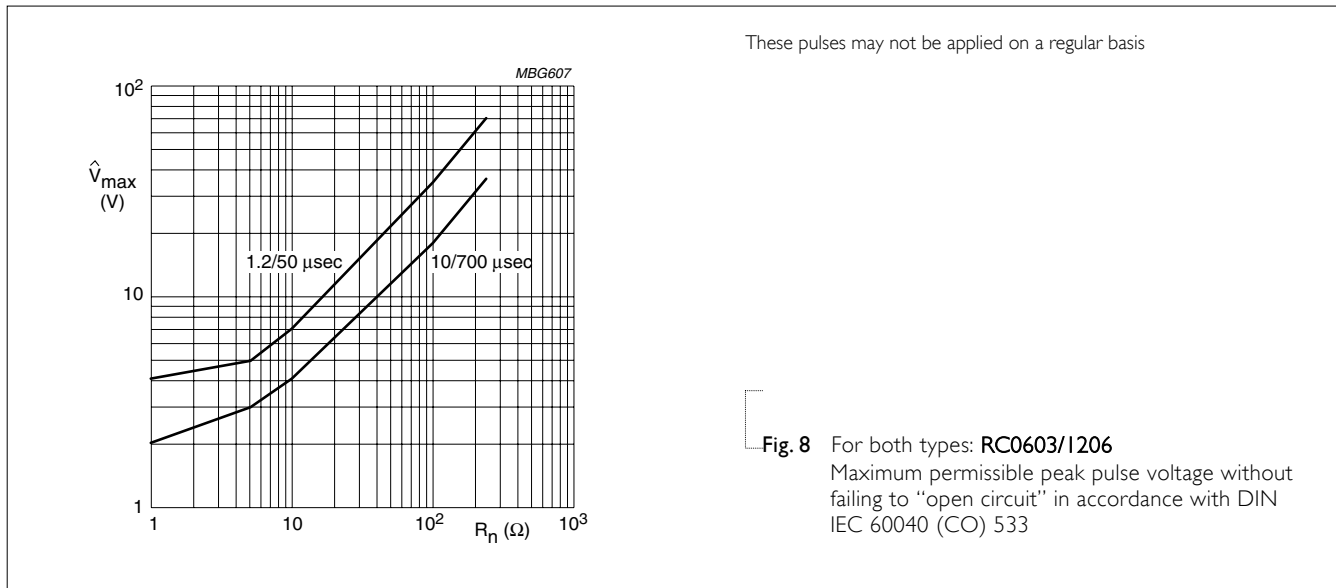
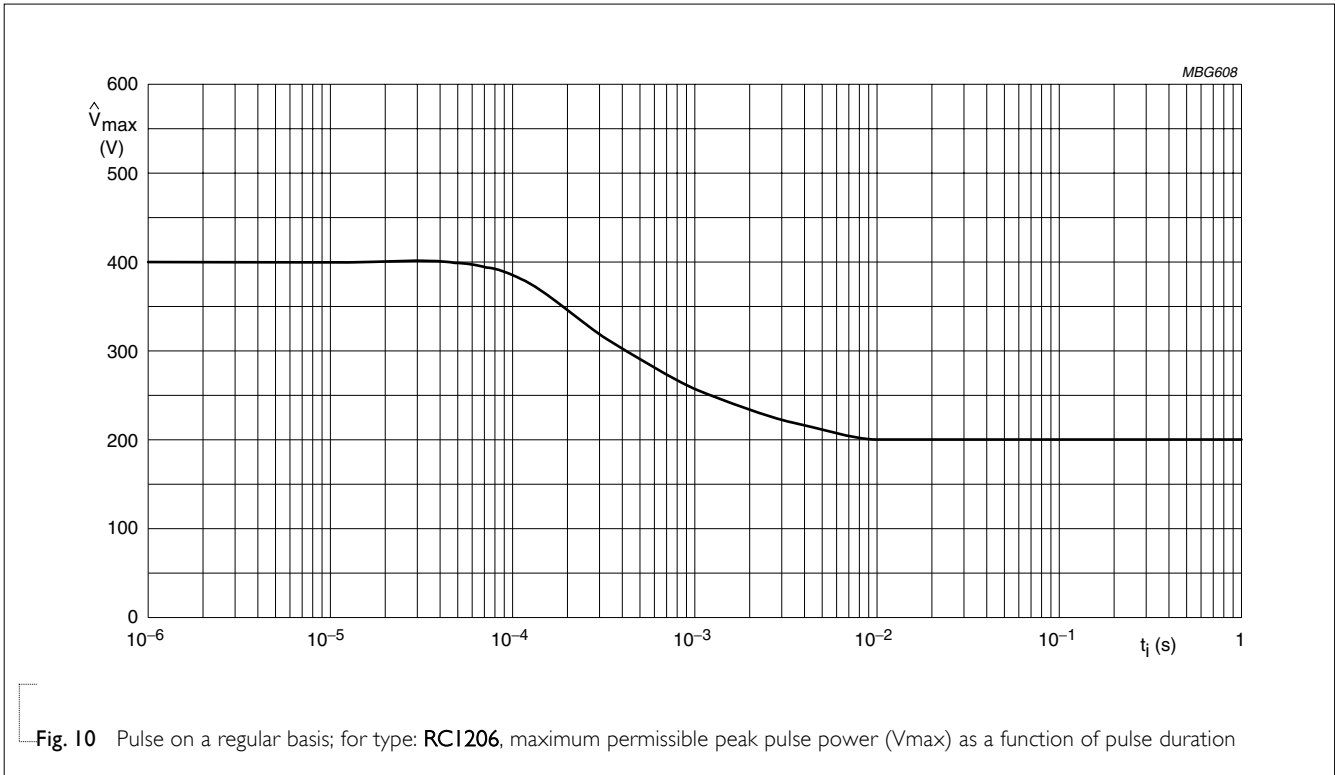
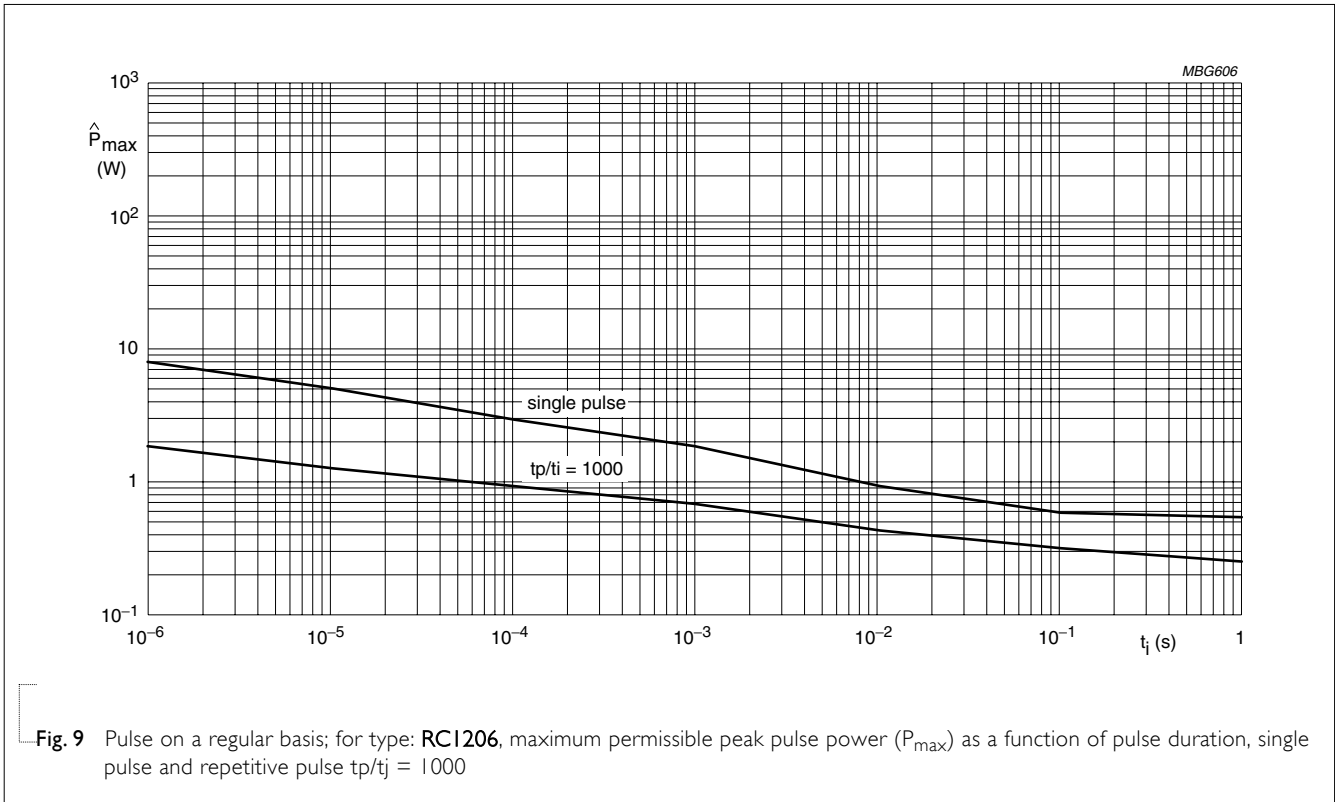

Fig. 8 For both types: RC0603/1206
Maximum permissible peak pulse voltage without failing to "open circuit" in accordance with DIN IEC 60040 (CO) 533



TESTS AND REQUIREMENTS

Table 5 Test condition, procedure and requirements

TEST	TEST METHOD	PROCEDURE	REQUIREMENTS
Temperature Coefficient of Resistance (T.C.R.)	MIL-STD-202F-method 304;	At +25/-55 °C and +25/+125 °C	Refer to table 2
	JIS C 5202-4.8	<p>Formula:</p> $T.C.R = \frac{R_2 - R_1}{R_1(t_2 - t_1)} \times 10^6 \text{ (ppm/°C)}$ <p>Where $t_1 = +25 \text{ °C}$ or specified room temperature $t_2 = -55 \text{ °C}$ or +125 °C test temperature $R_1 =$resistance at reference temperature in ohms $R_2 =$resistance at test temperature in ohms</p>	
Thermal Shock	MIL-STD-202F-method 107G; IEC 60115-1 4.19	At -65 (+0/-10) °C for 2 minutes and at +125 (+10/-0) °C for 2 minutes; 25 cycles	±(1.0%+0.05 Ω)
Low Temperature Operation	MIL-R-55342D-Para 4.7.4	At -65 (+0/-5) °C for 1 hour; RCWV applied for 45 (+5/-0) minutes	±(1.0%+0.05 Ω) No visible damage
Short Time Overload	MIL-R-55342D-Para 4.7.5; IEC 60115-1 4.13	2.5 × RCWV applied for 5 seconds at room temperature	±(1.0%+0.05 Ω) No visible damage
Insulation Resistance	MIL-STD-202F-method 302; IEC 60115-1 4.6.1.1	One DC voltage (V) applied for 1 minute Details see below table 6	≥10 GΩ
Dielectric Withstand Voltage	MIL-STD-202F-method 301; IEC 60115-1 4.6.1.1	One AC voltage (V_{rms}) applied for 1 minute Details see below table 6	No breakdown or flashover
Resistance to Soldering Heat	MIL-STD-202F-method 210C; IEC 60115-1 4.18	Unmounted chips; 260 ±5 °C for 10 ±1 seconds	±(1.0%+0.05 Ω) No visible damage
Life	MIL-STD-202F-method 108A; IEC 60115-1 4.25.1	At 70±2 °C for 1,000 hours; RCWV applied for 1.5 hours on and 0.5 hour off	±(3%+0.05 Ω)
Solderability	MIL-STD-202F-method 208A; IEC 60115-1 4.17	Solder bath at 245±3 °C Dipping time: 2±0.5 seconds	Well tinned (≥95% covered) No visible damage

Table 5 Test condition, procedure and requirements (continued)

TEST	TEST METHOD	PROCEDURE	REQUIREMENTS	
Bending Strength	JIS C 5202.6.14;	Resistors mounted on a 90 mm glass epoxy resin PCB (FR4) Bending: 5 mm	±(1.0%+0.05 Ω)	
	IEC 60115-1 4.15		No visible damage	
Resistance to Solvent	MIL-STD-202F-method 215; IEC 60115-1 4.29	Isopropylalcohol (C ₃ H ₇ OH) or dichloromethane (CH ₂ Cl ₂) followed by brushing	No smeared	
Noise	JIS C 5202 5.9; IEC 60115-1 4.12	Maximum voltage (V _{rms}) applied	Resistors range	Value
			R < 100 Ω	10 dB
			100 Ω ≤ R < 1 KΩ	20 dB
			1 KΩ ≤ R < 10 KΩ	30 dB
			10 KΩ ≤ R < 100 KΩ	40 dB
			100 KΩ ≤ R < 1 MΩ	46 dB
1 MΩ ≤ R ≤ 22 MΩ	48 dB			
Humidity (steady state)	JIS C 5202 7.5; IEC 60115-8 4.24.8	1,000 hours; 40±2 °C; 93(+2/-3)% RH RCWV applied for 1.5 hours on and 0.5 hour off	±(2.0%+0.05 Ω)	
Leaching	EIA/IS 4.13B; IEC 60115-8 4.18	Solder bath at 260±5 °C Dipping time: 30±1 seconds	No visible damage	
Intermittent Overload	JIS C 5202 5.8	At room temperature; 2.5 × RCWV applied for 1 second on and 25 seconds off; total 10,000 cycles	±(2.0%+0.05 Ω)	
Resistance to Vibration	On request	On request		
Moisture Resistance Heat	MIL-STD-202F-method 106F;	42 cycles; total 1,000 hours Shown as Fig. 11	±(2.0%+0.05Ω)	
	IEC 60115-1 4.24.2		No visible damage	

Table 6 Criteria of rated continued working voltage and overload voltage

TYPE	FR0603	FR1206
Voltage (DC/unit: V); (AC/ unit: V _{rms})	100	500

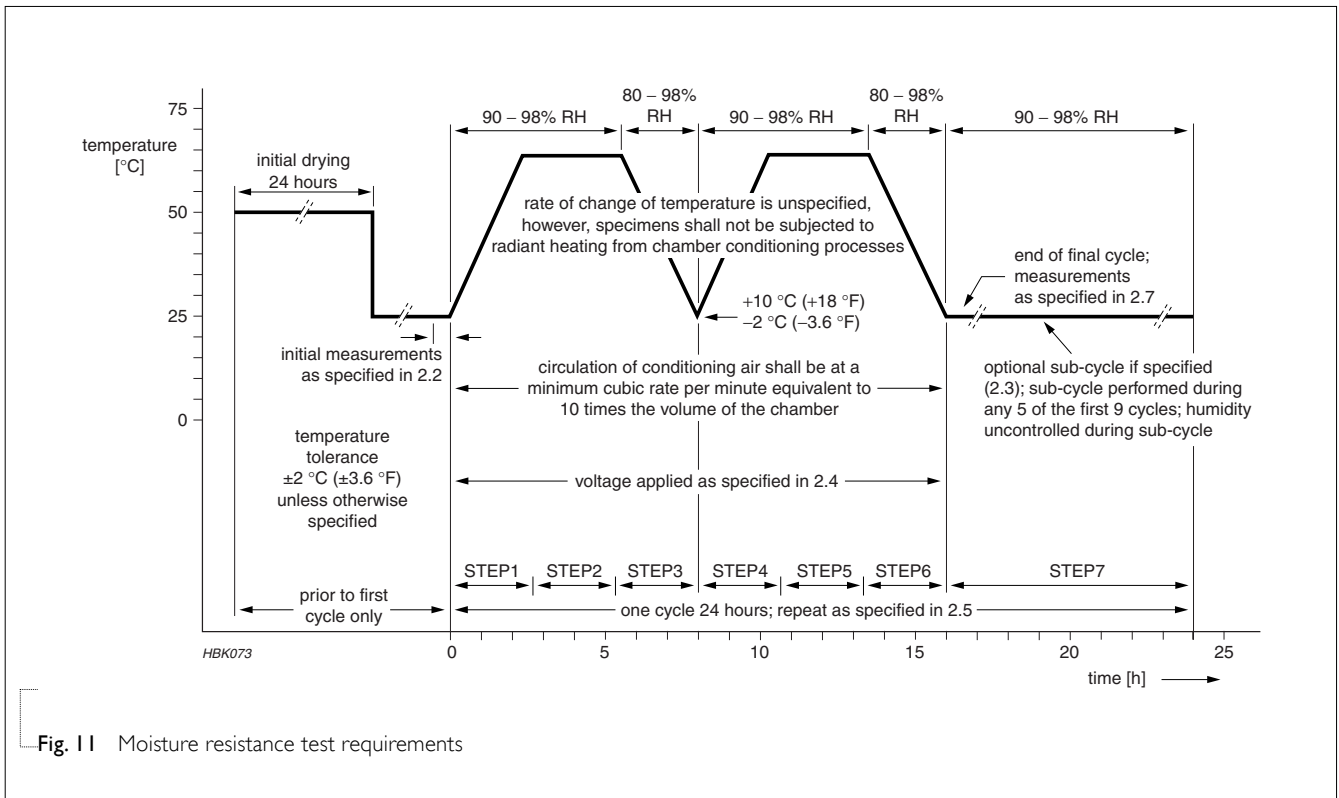

Fig. 11 Moisture resistance test requirements

REVISION HISTORY

REVISION	DATE	CHANGE NOTIFICATION	DESCRIPTION
----------	------	---------------------	-------------

Version 0	Sep 26, 2005	-	- First issue of this specification
-----------	--------------	---	-------------------------------------